



CONNECTION TECHNOLOGY SYSTEMS

MCT-RACK-18-MGM

**18 SLOTS COMPACT MEDIA
CONVERTER CENTER**

User's Guide

Version 0.90

Trademarks

CTS is a registered trademark of Connection Technology Systems Inc..
Contents are subject to revise without prior notice.
All other trademarks remain the property of their respective owners.

Copyright Statement

Copyright © Connection Technology Systems Inc..
This publication may not be reproduced as a whole or in part, in any way whatsoever unless prior consent has been obtained from Connection Technology Systems Inc..

FCC Warning

This equipment has been tested and found to comply with the limits for a Class-A digital device, pursuant to Part 15 of the FCC Rules. These limitations are designed to provide reasonable protection against harmful interference in a residential installation. This equipment generates uses and can radiate radio frequency energy. If this equipment is not installed properly and used in accordance with the instructions, may cause harmful interference to radio communications. However, there is no guarantee that interference will not occur in a particular installation. If this equipment does cause harmful interference to radio or television reception, which can be determined by turning the equipment off and on, the user is encouraged to try to correct the interference by one or more of the following measures:

- Reorient or relocate the receiving antenna.
- Increase the separation between the equipment and receiver.
- Connect the equipment into a different outlet from that the receiver is connected.
- Consult your local distributors or an experienced radio/TV technician for help.
- Shielded interface cables must be used in order to comply with emission limits.

Changes or modifications to the equipment, which are not approved by the party responsible for compliance, could affect the user's authority to operate the equipment.

Copyright © 2015 CONNECTION TECHNOLOGY SYSTEMS INC.,
All Rights Reserved.

Company has an on-going policy of upgrading its products and it may be possible that information in this document is not up-to-date. Please check with your local distributors for the latest information. No part of this document can be copied or reproduced in any form without written consent from the company.

Revision History

Version	Release Date	Description
0.90	20150916	First release

Table of Contents

1. INTRODUCTION	5
1.1 The MCT-RACK-18-MGM	5
1.2 Connectors, Indicators, and Switches	6
2. INSTALLATION	7
2.1 Requirement	7
2.2 Unpack MCT-RACK-18-MGM	8
2.3 Install MCT Series Media Converters	8
2.4 Install MCT-RACK-18-MGM	9
2.4.1 Standard 19-Inch Rack Installation	9
2.4.2 Desk Top Installation	10
2.5 Connect MCT Series Media Converters to network	10
2.6 Connect Power Supply	10
2.7 Power On the MCT-RACK-18-MGM	12
2.8 DI/DO Configuration (Coming Soon)	12
3. OPERATION	13
3.1 LED Status	13
4. MAINTENANCE	15
4.1 Fault Identification	15
4.2 Hardware Replacement Procedures	16
4.3 Firmware and Configuration Upgrade	16

1. INTRODUCTION

Thank you for choosing MCT-RACK-18-MGM. This CHASSIS is specifically designed to the managed media converter which required monitoring point-to-point connection for the deployment of FTTX applications. By selecting and installing from among of various MCT series media converters, MCT-RACK-18-MGM allows users to upgrade and integrate their existing network media by fiber easily.

1.1 The MCT-RACK-18-MGM

Connection Technology Systems (CTS) MCT-RACK-18-MGM, the universal media converter chassis, provides 18 slots for mixed installation of MCT series media converters. Up to 18 media converters can be powered by the MCT-RACK-18-MGM without the external power supply required. The MCT-RACK-18-MGM features a redundant power supply system to ensure reliably system operation even in case of one of power supply module failed.

Moreover, its miniature size allows MCT-RACK-18-MGM to be installed in a narrow space. All above user friendly designs make MCT-RACK-18-MGM be in a shape of high performance and reliability.

MCT-RACK-18-MGM can be used as a table top unit or mounted on a 19 inches standard rack by using 19 inches bracket accessories shipped together with the unit.

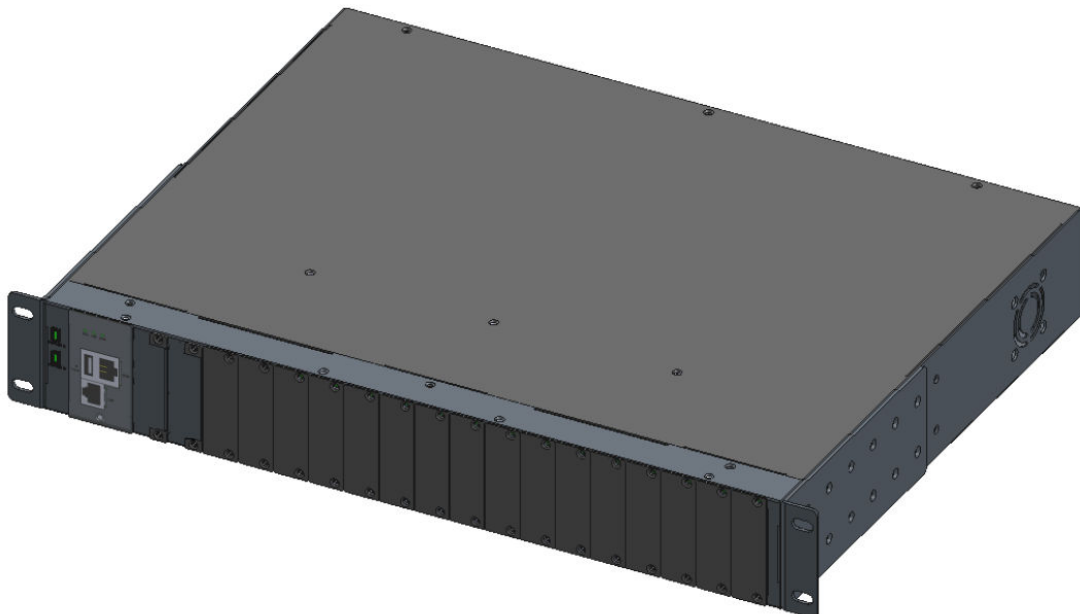

Hardware Features

- Hot-Swappable Converter Modules
- Hot-Swappable AC or DC Power Modules
- Power Redundancy
- Commercial Operation Temperature 0°C~50°C
- Plug & Play Design

Redundant Power Supply

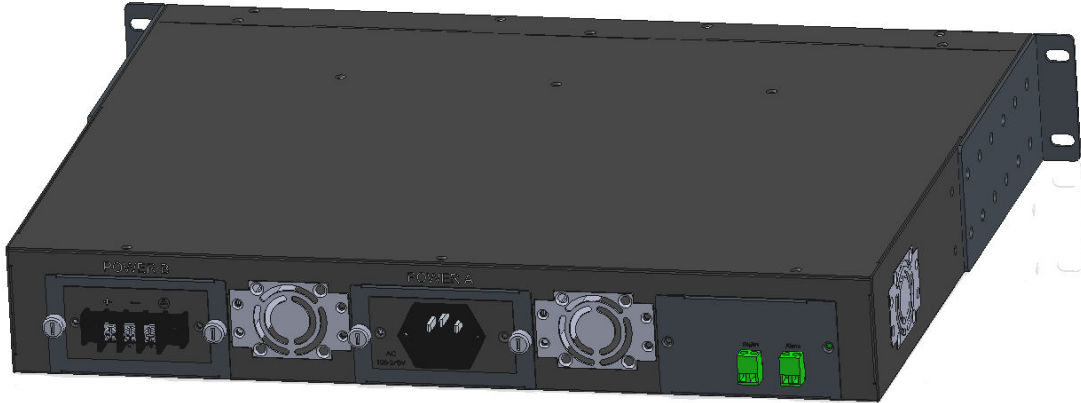

Redundant power supply is provided for non-stop running.

1.2 Connectors, Indicators, and Switches

Front Panel



- ❶ 10/100Mbps RJ-45 LAN port
- ❷ USB host
- ❸ Console RS232 port (RJ-45)
- ❹ LED Indicators
- ❺ Reset Button

Rear Panel

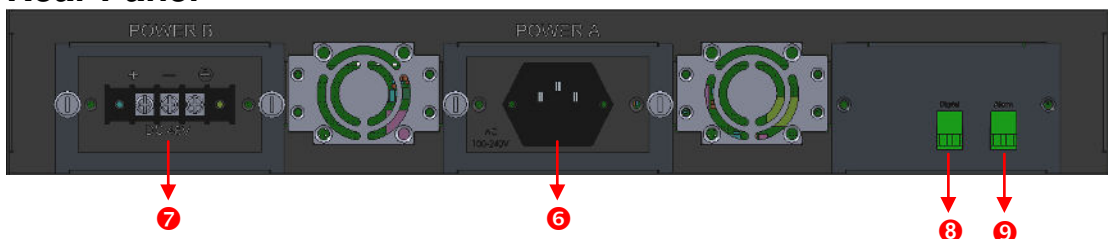

- ⑥ AC Power Connector
- ⑦ DC Power Connector
- ⑧ Digital Input Terminal Block
- ⑨ Digital Output (Alarm) Terminal Block

Power Requirement:

AC power: 100-240V, 50-60Hz,

DC power: 48VDC

2. INSTALLATION

The procedures for installing the MCT-RACK-18-MGM are as follows,

- 2.1 Requirement
- 2.2 Unpack MCT-RACK-18-MGM
- 2.3 Install MCT Series Media Converters
- 2.4 Install MCT-RACK-18-MGM
- 2.5 Connect MCT Series Media Converters to network
- 2.6 Connect Power Supply
- 2.7 Power on the MCT-RACK-18-MGM

2.1 Requirement

MCT-RACK-18-MGM basic requirements for installation are as follow,

- Environmental conditions.
 - One power outlet for MCT-RACK-18-MGM internal power supply
 - One power outlet for Redundant Power Supply
 - Proper ventilation
 - Away from electrical noise, radio, etc.
 - UTP cables should not run in the same duct with power and phone line cables
- Required MCT series media converters
- Required Fiber and UTP cables
- Redundant Power Supply
- Rack mounting tools

2.2 Unpack MCT-RACK-18-MGM

Following items should be checked after opening the shipping package.

1. MCT-RACK-18-MGM x 1
2. Slider Set x 20
3. Power Cord
4. Rubber Foot x 4
5. Pulling Cable x 1
6. Console Cable x 1

2.3 Install MCT Series Media Converters



CAUTION

To prevent any damage or failure of the MCT series media converters, please wear a grounding device and observe electrostatic discharge precautions before install into the MCT-RACK-18-MGM.

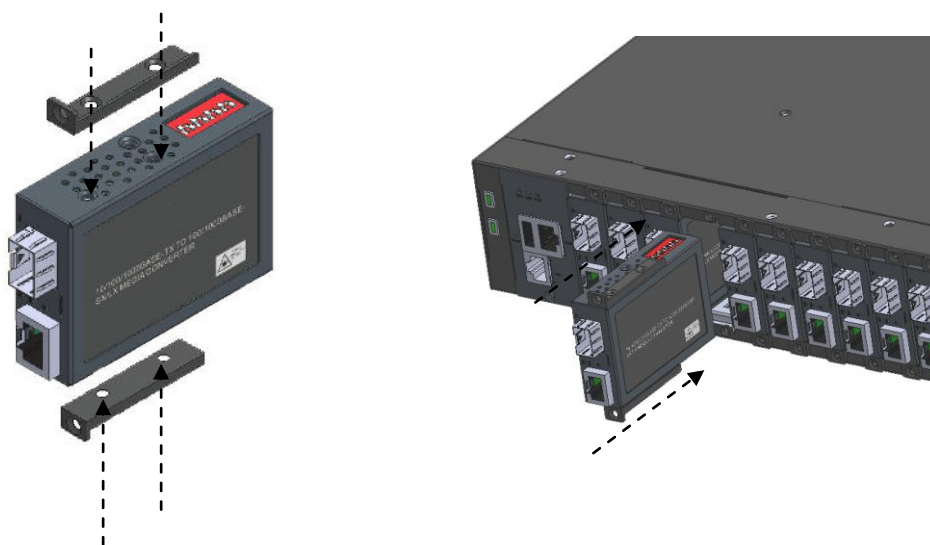

Procedures:

1. Plan the MCT Series Media Converters slot positions
 - All slots are identical
 - MCT Series Media Converters can be installed into any slots
2. Remove the protective plate from selected installation slot
3. Attach fasteners on converter's both side and fix the fastener screw.
4. Insert MCT Series Media Converters carefully into the selected slot
 - Make sure that the MCT Series Media Converters is firmly connected with the middle plane connector.
5. Fix the fastener screw on MCT-RACK-18-MGM.
6. Repeat steps 2 to 5 for all the MCT Series Media Converters.

7. You may connect the supplied pulling cable with a media converter to pull it out more easily.

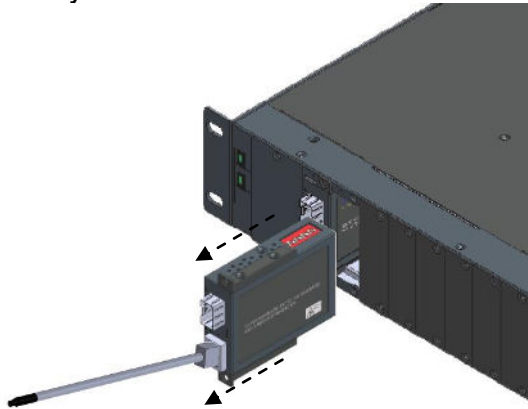

2.4 Install MCT-RACK-18-MGM



CAUTION

To prevent any damage or failure of the MCT-RACK-18-MGM and MCT Series Media Converters, do not block the bottom of the MCT-RACK-18-MGM.

2.4.1 Standard 19-Inch Rack Installation



WARNING

Please mount the MCT-RACK-18-MGM firmly in rack otherwise the MCT-RACK-18-MGM may fall and cause the system damage and possible injury to personnel.

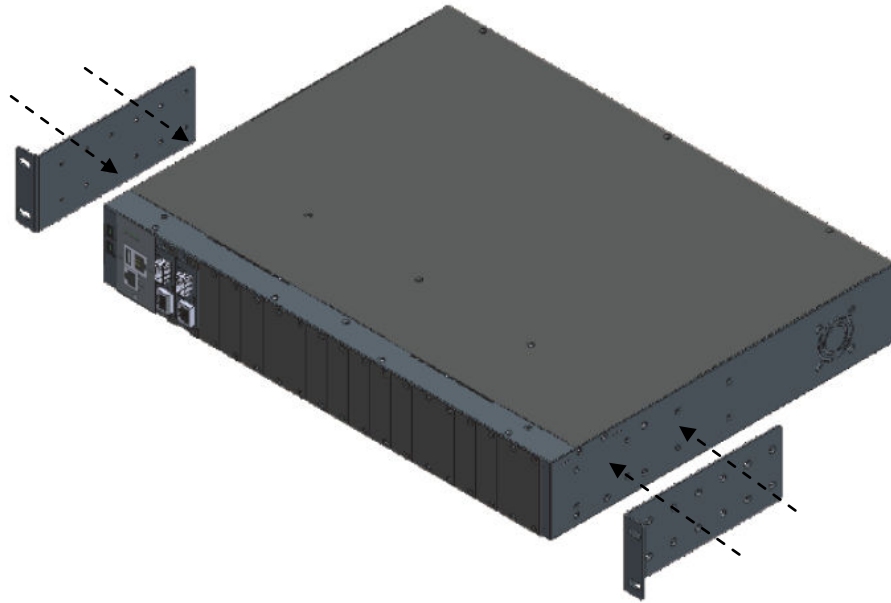

Procedure:

1. Plan the MCT-RACK-18-MGM rack position
2. Fix both mounting brackets into the MCT-RACK-18-MGM
3. Align the MCT-RACK-18-MGM with mounting bracket into the selected mounting rail position
4. Fix the MCT-RACK-18-MGM with mounting brackets into the selected mounting rails position carefully and firmly.

2.4.2 Desk Top Installation

1. Plan the MCT-RACK-18-MGM desk top position.
2. Place the MCT-RACK-18-MGM on a well ventilated, flat and firmly desk.

2.5 Connect MCT Series Media Converters to network

Please refer to the User's Manual that comes with the MCT Series Media Converters for cabling specifications and direction.

2.6 Connect Power Supply



WARNING

Do NOT turn on power source switch before connecting with MCT-RACK-18-MGM. Inappropriate operation may cause system damage, possible injury or casualty.

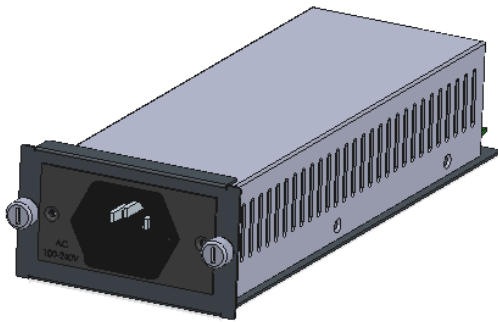

AC Power Module

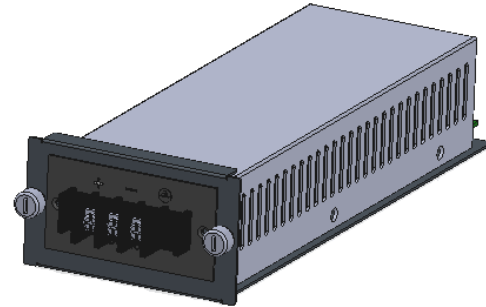

DC Power Module

Procedure:

1. Insert new AC/DC power supply carefully into the slot. Make sure that the AC/DC power supply is firmly connected with the middle plane connector.
2. Fix the fastener screw.

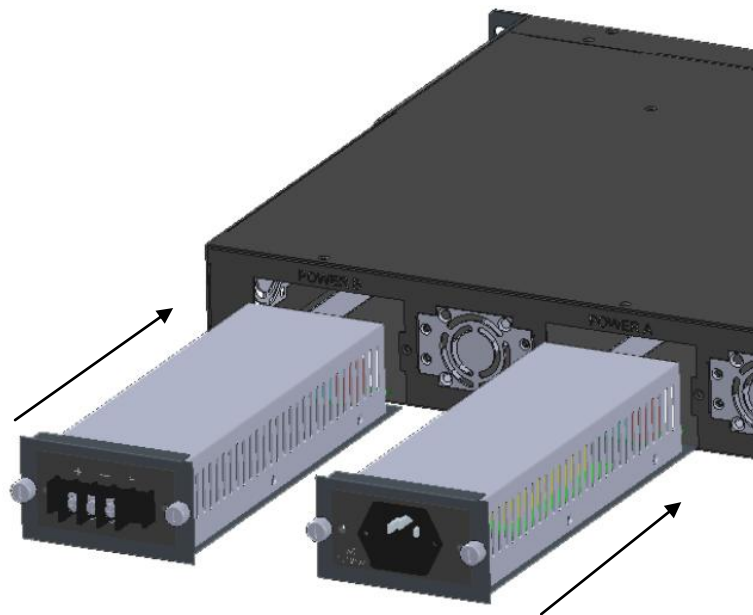

NOTE:

1. Power Supply is hot swappable.
2. Power supply is active and concurrent with internal power supply

2.7 Power On the MCT-RACK-18-MGM

Procedure:

1. Check the power outlet
2. Connect the power cord to the power outlet
3. Turn on the MCT-RACK-18-MGM power source
4. Verify the MCT-RACK-18-MGM status
5. Power LED is on

2.8 DI/DO Configuration (Coming Soon)

Digital Output (Alarm) is a port connection on the terminal blocks used to connect alarm devices such as Buzzer, LED or Flash Lamp to alert operator when the abnormality is detected.

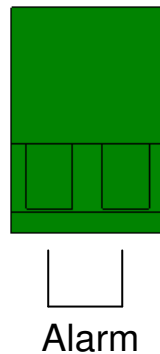

Alarm Wiring Configuration

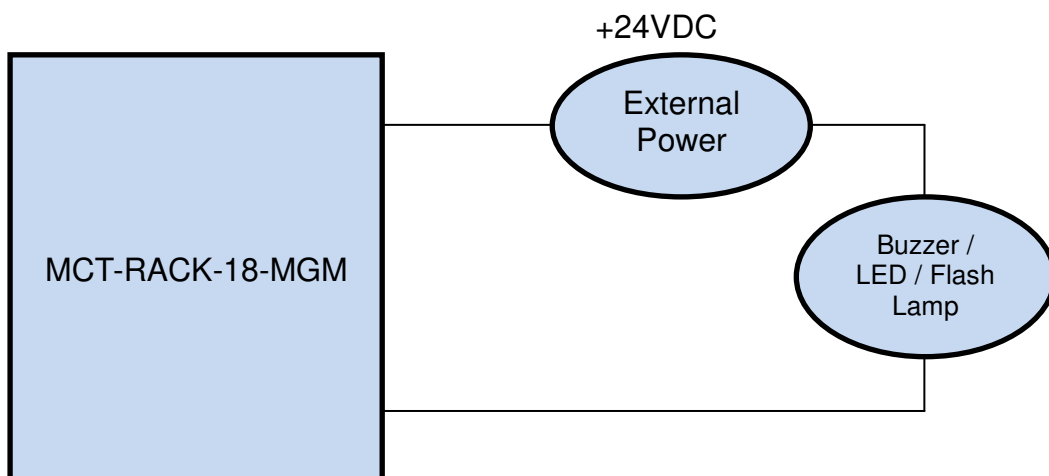

Digital Input is a digital input connection on the terminal blocks used to detect if a voltage is above/below a specific threshold.

Digital Input Configuration

Insert the positive and negative (signal ground) wires into the “+” and “-” contact on the terminal blocks.

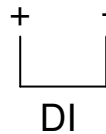
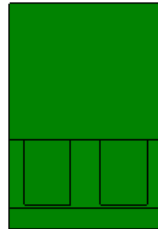

3. OPERATION

MCT-RACK-18-MGM is easy to operate; no special training is required. However, customers may perform local or remote status monitor through,

1. LED status
2. Console
3. SNMP Manager

3.1 LED Status

CHASSIS LED

LED	Definiation	Color	Operation
Power A Power B	Power Status	Green	Primary power is on
		Off	Primary power is down or fail
STA	System Status	Orange	System is booting up.
		Orange Blinking	When the system is set back to default factory setting, the Status LED indicator will blink 3 times in orange.
			When the system is restarted, the Status LED indicator will blink once in orange.
			System is undergoing upgrading procedure.
LAN	LAN Port Status	Green	The link is up and the speed is 10/100 Mbps
		Off	No connection
COM	Console Port Status	Green	Console port is connected
		Off	No connection

MCT Series Media Converter LED

Please refer to the User's Manual that comes with the MCT Series Media Converters for LED indications.

4. MAINTENANCE

MCT-RACK-18-MGM is easy to maintain, we suggest the following procedures when problem occurring.

4.1 Fault Identification

- Local check

4.2 Hardware Replacement Procedures

- Replace MCT Series Media Converter
- Replace AC or DC Power Supply

4.1 Fault Identification

Fault identification can help users quickly locate the problem and take proper actions to solve the problems.

Local Check

Check all MCT-RACK-18-MGM LED status and cable connections.

Whole System no Function

1. Check Power LED status
2. Check Power connection
3. Reset MCT-RACK-18-MGM power

Certain Network Link no Function

1. Locate related MCT Series Media Converter
2. Check MCT Series Media Converter connection with middle plane
3. Check MCT Series Media Converter Power LED status
4. Check MCT Series Media Converter Link LED status
5. Check UTP connection between the MCT Series Media Converter and related device
6. Check Fiber connection between the MCT Series Media Converters and related device
7. Reset MCT Series Media Converter

4.2 Hardware Replacement Procedures



WARNING

The MCT-RACK-18-MGM contains no user-serviceable parts. **DO NOT, UNDER ANY CIRCUMSTANCES, open and attempt to repair it. Failure to observe this warning could result in personal injury or death from electrical shock.**

Failure to observe the above warning will immediately void any Warranty.

Replace MCT Series Media Converter

Procedure:

1. Remove the existing MCT Series Media Converter
2. Insert new MCT Series Media Converter carefully into the slot
 - ✓ Make sure that the MCT Series Media Converter is firmly connected with the middle plane connector.
3. Fix the fastener screw.

Replace AC/DC Power Supply

Procedure:

1. Remove the existing AC/DC power supply
2. Insert new AC/DC power supply carefully into the slot
 - ✓ Make sure that the AC/DC power supply is firmly connected with the middle plane connector.
3. Fix the fastener screw.

4.3 Firmware and Configuration Upgrade

This MCT-RACK-18-MGM may perform firmware and configuration upgrading when required. New firmware can be obtained from your sales representative. For detailed upgrading procedures, please refer to the Network Management User's Manual.

Automatic Firmware and Configuration Upgrade via USB host

The MCT-RACK-18-MGM's firmware and configuration can also be upgraded automatically via USB host.

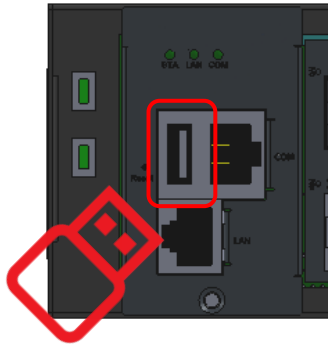

- Allows the network administrator for provisioning a device by just powering on and inserting disk
- Automatically upgrade firmware and/or configuration when plug in an USB flash disk or hard disk

USB support

- Flash disk or hard disk (USB mass storage) with partition (Logic unit number, LUN)
- File system : FAT12, FAT16, FAT32, NTFS3.1(read-only) and before

Automatic Firmware and Configuration Upgrade Process



Preparation steps before inserting the USB disk

- Rename the firmware name as:
cts-fw-MCT-RACK.<admin_user>.<password>
- Rename the configuration file name as:
cts-cfg-MCT-RACK.<admin_user>.<password>

